

Expected Seating Arrangement Questions for Bank Clerk Prelims Exams

We Exam Pundit Team, has made “**BOOST UP PDFS**” Series to provide The Best Free PDF Study Materials on All Topics of Reasoning, Quantitative Aptitude & English Section. This Boost Up PDFs brings you questions in different level, Easy, Moderate & Hard, and also in New Pattern Questions. Each PDFs contains 50 Questions along with Explanation. For More PDF Visit: pdf.exampundit.in

(Directions 1–5): Study the following information carefully and answer the questions given below it.

Seven Persons Arun, Babu, Karthik, Kavin, Velu, Rahul and Prabhu are sitting in the linear row facing north. They speak seven different languages Hindi, Tamil, Malayalam, Bengali, Telugu, Kannada and Marathi but not necessarily in the same order. No two people speak same language.

Babu speaks Telugu language. Only two persons are sitting to the left of Babu. Only one person is sitting between Babu and Kavin. Rahul sits second to the right of Kavin. Velu speaks Marathi. Only three persons sits between Velu and Prabhu. Only one person is sitting between Prabhu and one who speak Malayalam. One who speaks Malayalam is not sitting at the extreme ends. Arun speaks Hindi. Velu is not the immediate neighbour of Arun. One who speaks Bengali sits second to the right of one who speaks Kannada.

1) Who among the following sits one of the extreme ends?

- a) Rahul b) Velu c) Kavin d) Karthik
e) None of these

2) Who sits second to the left of Karthik?

- a) Arun b) Babu c) Prabhu d) Velu
e) None of these

3) Four of the following five are alike in a certain way thus forms a group. Find the one who does not belongs to the group?

- a) Velu b) Babu c) Kavin d) Karthik e) Rahul

4) Which of the following language does Karthik Speaks?

- a) Malayalam b) Tamil c) Telugu d) Kannada
e) None of these

5) How many persons sit to the left of the one who speaks Tamil?

- a) One b) Two c) Three d) Four e) None

Directions (6-10): Study the following information carefully and answer the questions given below:

Eight persons A, B, C, D, E, F, G and H are sitting in a circular table and facing outside. They like different subjects viz. Tamil, English, Chemistry, Physics, Hindi, History, Maths and Civics but not necessarily in the same order.

A likes Hindi. D sits second to the right of A. Only two persons sit between D and B. The one who likes Tamil sits opposite to B. Only one person sits between C and G. Only three persons sit between the one who likes English and Civics. D does not like Civics. Only one person sits between B and C. C is not an immediate neighbour of A. Only two persons sit between

Expected Seating Arrangement Questions for Bank Clerk Prelims Exams

F and E. F is one of the immediate neighbour of B. E does not like Tamil. E likes history. The one who likes Maths sits second to the right of the one who like Chemistry. The one who likes chemistry is not an immediate neighbour of H. Only two persons sit between F and the one who likes History.

6) Who among the following likes Chemistry?

a) C b) A c) B d) C e) None of these

7) Who sits opposite to the one who like Maths?

a) C b) G c) A d) B e) None of these

8) Who sits third to the right of D?

a) G b) C c) D d) B e) A

9) H likes which of the following subject?

a) Civics b) Tamil c) English d) Chemistry
e) None of these

10) Four of the following five are alike in a certain way thus forms a group. Find the one which does not belong to the group?

a) A-D b) F-H c) G-C d) H-A e) G-D

(Directions 11–15): Study the following information carefully and answer the questions given below it.

Ten people A, B, C, D, E, P, Q, R, S and T are sitting in two rows. Five people in each row facing each other. A, B, C, D and E are facing north. P, Q, R, S and T are facing south but not necessarily in the same order.

C sits third to the right of A. One who is sitting opposite to C sits immediate left of R. Only one person sitting between R and T. T is sitting one of the right positions of R. Only two people are sitting between T and S. One who is sitting opposite to Q sits third to the left of B. But

B is not sitting at the extreme ends. Number of persons sitting to the left of P and number of persons sitting to the Left of E is same.

11) Who among the following sits diagonally opposite to S?

a) D b) A c) B d) C e) None of these

12) Who among the following does not belong to the group?

a) Q b) S c) C d) D e) E

13) Who sits opposite to A?

a) P b) Q c) R d) T e) S

14) How many persons sitting between D and C?

a) One b) Two c) Three d) Four e) None

15) Who sits second right of S?

a) P b) Q c) R d) S e) T

(Directions 16–20): Study the following information carefully and answer the questions given below it.

Eight persons P, Q, R, S, T, U, V and W are sitting in the circular table. Some of them are facing inside and some of them are facing outside but not necessarily in the same order.

Q sits second to the left of P. Only two person sits between Q and S. S is not the immediate neighbour of P. U sits second to the left of W. Only three persons are sitting between V and W. But W is not the immediate neighbour of P. S is facing opposite direction as P. R is sitting immediate left of S. Immediate neighbour of T are facing same direction. T is facing inside. Q sits second to the right of R. Not more than one person sitting together is facing same direction. U is not the immediate neighbor

Expected Seating Arrangement Questions for Bank Clerk Prelims Exams

of S. U faces opposite direction that of Q. Q faces same direction as T.

16) Who among the following sits to the immediate right of S?

a) P b) Q c) R d) T e) None of these

17) Who among the following sits opposite to R?

a) P b) U c) V d) S e) None of these

18) How many persons are facing inside?

a) One b) Two c) Three d) Four

e) None of these

19) Four of the following five are alike in a certain way thus forms a group. Find the one that does not belong to the group?

a) T b) U c) W d) S e) V

20) How many persons are sitting between Q and T when counted in clockwise direction from T?

a) One b) Two c) Three d) Four e) None

Directions (21–25): Study the following information carefully and answer the questions given below it.

Eleven persons A, B, C, D, E, F, G, H, I, J and K sits in the circle and facing the centre but not necessarily in the same order.

D sits third to the right of B and three persons sit between D and I. A does not sits near to I. K sits second to the right of A and K does not sit near to D. Three persons sit between I and J. C sits third to the right of K. E is not the immediate neighbour of A and D. G sits second to the left of H.

21) Who sits second to the left of J?

a) F b) A c) H d) K e) D

22) How many persons sit between A and G when counted from left of A?

a) Four b) Three c) Five d) Two e) None

23) Who sits second to the right of the person who sits third to the left of H?

a) G b) C c) E d) D e) I

24) When we arrange all the persons in alphabetical order starting from A in clockwise direction (excluding A) then the position of how many persons does not change?

a) Two b) One c) Four d) Three e) None

25) Who sits fourth to the right of F?

a) C b) G c) A d) B e) D

(Directions 26–30): Study the following information carefully and answer the questions given below it.

There are six persons P, Q, R, S, T and U are sitting in a triangular shaped seating arrangement. Three persons are sitting at the corner of the triangle facing outside. Three Persons are sitting at the sides of the triangle facing inside. The persons are in different occupations lawyer, politician, doctor, teacher, astrologer and scientist not necessarily in the same order.

Two persons sit between scientist and politician. One person sits between teacher and lawyer. Astrologer sits second to the right of the politician. U sits second to the right of the astrologer. U and T sits adjacent to each other. S sits second to the left of T. Q sits second to the right of politician. Teacher sits immediate left of politician. Lawyer sits at one of the corners of the

Expected Seating Arrangement Questions for Bank Clerk Prelims Exams

triangle. P sits to the immediate left of T. S is not a doctor.

26) Who among the following sits to the immediate right of teacher?

- a) Doctor b) Lawyer c) Politician
d) Astrologer e) None of these

27) Who among the following sits opposite to doctor?

- a) P b) Q c) S d) T e) None of these

28) What is the occupation of R?

- a) Lawyer b) Politician c) Scientist
d) Teacher e) None of these

29) Who among the following sits exactly between S and R?

- a) Q b) R c) U
d) Cannot be determined
e) Either R or U.

30) Who sits second to the left of the doctor?

- a) Politician b) Doctor
c) Astrologer d) Lawyer
e) None of these

(Directions 31–35): Study the following information carefully and answer the questions given below it.

Ten persons are going to ten different cities Pune, Mumbai, Shimla, Jaipur, Chennai, Raipur, Agra, Patna, Kolkata and Delhi not necessarily in the same order. They are sitting in two parallel rows five persons per each row. In row 1 all are facing south and in row 2 all are facing north.

The person who goes to Agra sits opposite to one who is adjacent to the person who goes to Mumbai. One person

sits between Agra and Pune. Person who goes to Chennai sits immediate right of the person who goes to Delhi. Person from Jaipur sits one of the extreme ends of the row and also sits second to either side of the person who goes to Delhi and both are in same row with the person who goes to Chennai. The person who goes to Mumbai and the person who goes to Shimla are sits diagonally opposite to each other. Person who goes to Kolkata sits second to the right of the person who goes to Raipur. Person who goes to Agra is not facing the person who goes to Patna. Person to Patna faces north.

31) Who among the following person is not comes under the group?

- a) Kolkata b) Raipur c) Mumbai d) Pune
e) Agra

32) Who among the following sits opposite to the person goes to Raipur?

- a) Delhi b) Kolkata c) Patna d) Mumbai
e) None of these

33) Who sits to immediate left of person from Kolkata?

- a) Agra b) Patna c) Pune d) Shimla e) None of these

34) Who sits between the persons who goes to Delhi and Mumbai?

- a) Pune b) Chennai c) Raipur d) Delhi
e) None of these

35) How many persons sit between Agra and Kolkata?

- a) One b) Two c) No one d) Ten e) None of these

Expected Seating Arrangement Questions for Bank Clerk Prelims Exams

Directions (36-40): Study the following information carefully and answer the questions given below.

Eight persons are sitting in two parallel rows. Four persons are sitting in each row. The persons sitting in Row 1 is facing north and the persons sitting in row 2 facing south Such that each person in row 1 exactly faces the person sitting in row 2.

F faces the person who sits second to the right of G. H sits second to the left of I. H is facing N. H doesn't sits at any extreme ends. E and C sit in the same row. D sits in Row 1. C and F don't sits in the same row. F and C don't face each other.

36) Who sits second to the left of E?

- a) H b) G c) I d) C e) None of these

37) What is the position of I with respect to D?

- a) Immediate Left b) Second to the left
c) Third to the right d) None of these
e) Immediate Right

38) Who sits opposite to the one who sits immediate right of N?

- a) The one who sits immediate right of H
b) The one who sits second to the right of D
c) The one who sits extreme right end of the Row
d) The one who faces the person who sits second to the right of G
e) None of these

39) Four of the Five among the following are similar in such a way in their arrangement to form a group, which one of the following doesn't belongs to the group?

- a) E b) C c) G d) I e) F

40) Which of the following statement is correct?

- a) N and G are immediate neighbors
b) Only one person sits between D and F
c) More than two persons sit to the left of E
d) Number of person sitting to the left of H is one less than that of number of person sits right of G
e) All of the statements are correct

(Directions 41-45): Study the following information carefully to answer the given questions:

Eight persons M, R, S, Q, W, P, H and T are sitting around a circular table facing centre but not necessarily in the same order. Each one of them has different mobile Oppo, Vivo, Nokia and Samsung. Not more than two persons have same mobiles.

Only one person sits between M and R. Two persons sit between R and Q. Q and M are not immediate neighbours. Person sitting on opposite sides have same mobiles. R has Samsung mobile and sits second to the right of S. The one who has Nokia mobile does not sit immediate left of the one who has Samsung mobile. S and the one who has Oppo mobile are not immediate neighbour. W is an immediate neighbour of the one who has Vivo mobile. The one who has Nokia mobile sits second to the right of H. T does not have Vivo mobile.

41) Which of the following person sits third to the left of T?

- a) Q b) W c) S
d) The one who has Oppo mobile
e) Both option (c) and option (d)

Expected Seating Arrangement Questions for Bank Clerk Prelims Exams

42) How many persons sit between Q and R, when counted from right of R?

- a) One
- b) Two
- c) Three
- d) Four
- e) None of these

43) If W is related to Samsung, M is related to Oppo, Q is related to which of the following?

- a) Oppo
- b) Vivo
- c) Nokia
- d) Samsung
- e) Cannot be determined

44) Which of the following is true?

- a) P and the one who likes Nokia are immediate neighbours
- b) H and the one who likes Samsung are not immediate neighbours
- c) As many persons sit between P and Q sit between R and M
- d) Less than two persons sit between W and S, when counted from left of W
- e) None is true

45) Four of the following five are alike in a certain way based on the above arrangement. Find which one does not belongs to that group?

- a) Q-Samsung
- b) H-Oppo
- c) R-Vivo
- d) S-Nokia
- e) M-Samsung

Directions (46-50): Study the following information carefully to answer the given questions:

Eight persons K, H, T, E, D, W, Q and S are sitting in a square table. Four persons sit at corner and four persons sit at middle side of the table. Person those sitting at corner faces the centre and Person those sitting at middle side of the table faces away from the centre.

Three persons sit between K and H. As many persons sit between H and D sits between D and K. Q sits immediate left of D. Q and K are not immediate neighbours. As many persons sit between T and W sits between W and S. W does not faces away from the centre. H and S are not immediate neighbours. Q does not sit opposite to S.

46) How many persons sit between Q and E, when counted from left of Q?

- a) One
- b) Two
- c) Four
- d) Three
- e) None of these

47) Which of the following statement is true?

- a) E sits third to the right of S
- b) W sits opposite to D
- c) As many persons sit between Q and H sits between D and S
- d) Only one person sits between T and S
- e) None is true

48) Which of the following person sits fifth to the left of S?

- a) Q
- b) The one who is Immediate left of T
- c) The one who is Immediate left of Q
- d) The one who is Second to the right of D
- e) None of these

49) If all the persons are made to sit alphabetically from D in clockwise direction, then how many persons remain unchanged?

- a) None
- b) One
- c) Two
- d) Three
- e) None of these

Expected Seating Arrangement Questions for Bank Clerk Prelims Exams

50) Who sits second to the left of the one who sits opposite to E?

a) K b) Q c) T d) H e) None of these

[Click Here for More Reasoning Practice Questions PDFs](#)

[Click Here to Join Our What's App Group & Get Instant Notification on Study Materials & PDFs](#)

[Click Here to Join Our Official Telegram Channel](#)

[Answer with Detailed Explanation](#)

Directions (1-5):

1. Answer: A

2. Answer: C

3. Answer: E

4. Answer: A

5. Answer: A

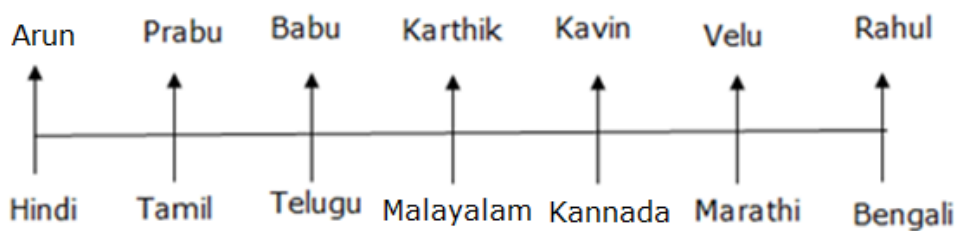

Babu speaks Telugu language. Only two persons are sitting to the left of Babu. Only one person is sitting between Babu and Kavin. Rahul sits second to the right of Kavin.

Expected Seating Arrangement Questions for Bank Clerk Prelims Exams

Case (1)

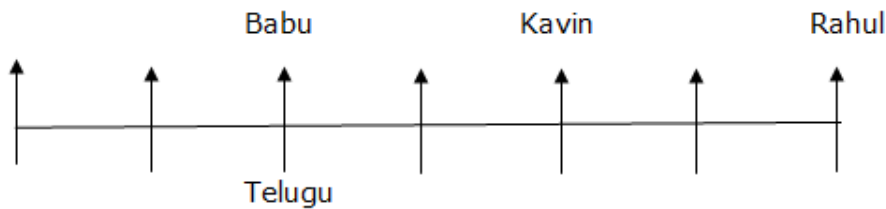

~~Case (2)~~

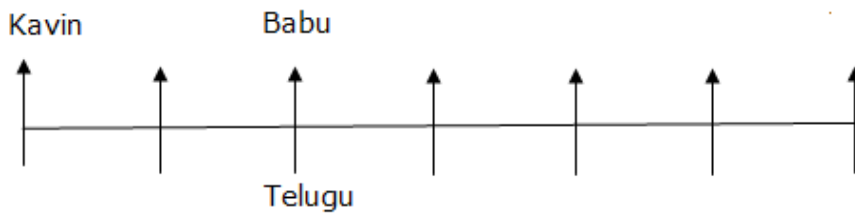

Velu speaks Marathi. Only three persons are sitting between Velu and Prabhu.

Case (1a)

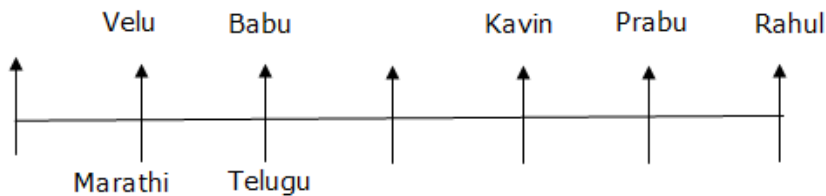

Case (1b)

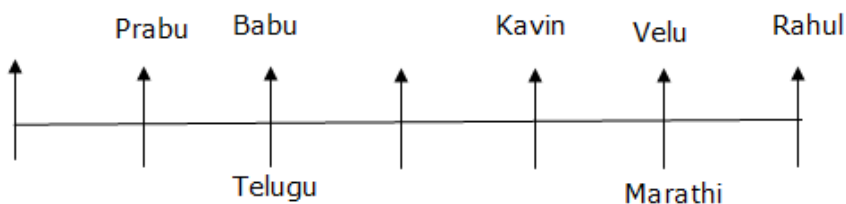

Expected Seating Arrangement Questions for Bank Clerk Prelims Exams

Only one person is sitting between Prabhu and the one who speak Malayalam. One who speaks Malayalam is not sitting at the extreme ends.

Case (1a)

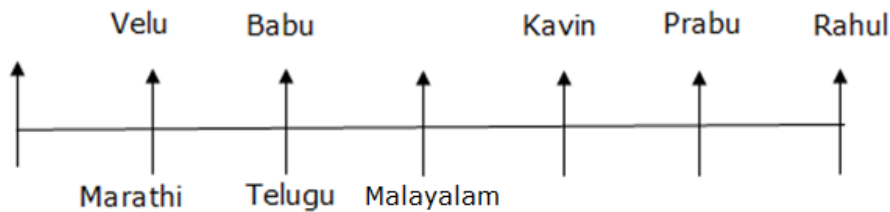

Case (1b)

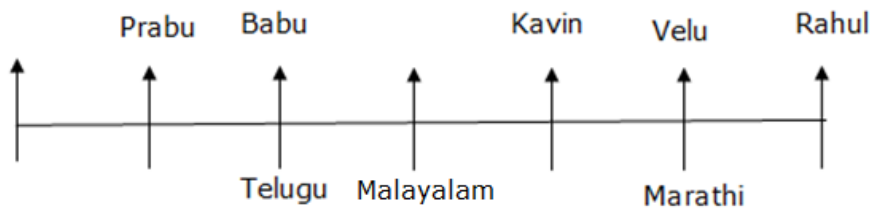

Arun speaks Hindi. Velu is not the immediate neighbour of Arun. Since Case (1a) is not possible.

~~Case (1a)~~

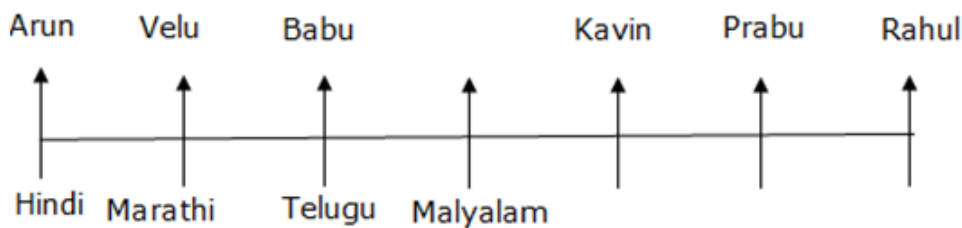

Expected Seating Arrangement Questions for Bank Clerk Prelims Exams

Case (1b)

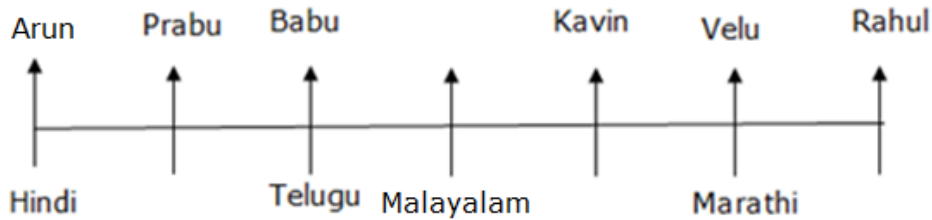

One who speaks Bengali sits second to the right of one who speaks Kannada.

Case (1b)

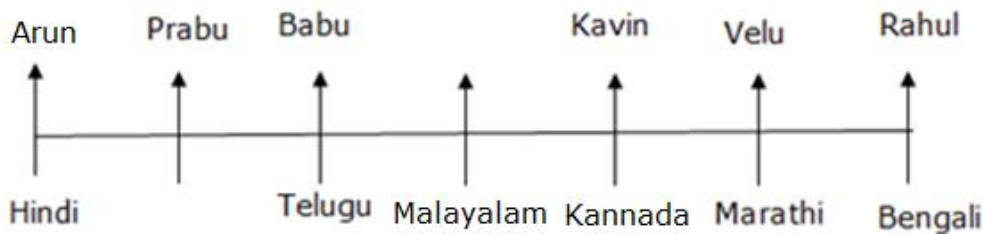

So the final arrangement is,

Case (1b)

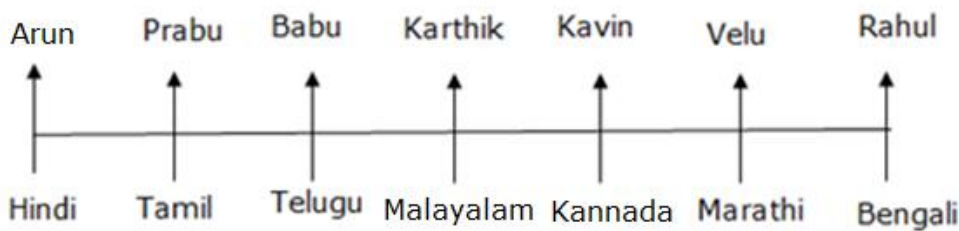

Directions (6-10):

6. Answer: A
7. Answer: B
8. Answer: D
9. Answer: A
10. Answer: E

Expected Seating Arrangement Questions for Bank Clerk Prelims Exams

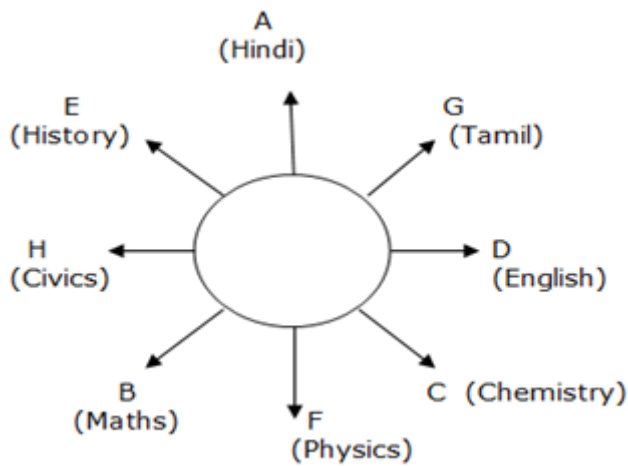

Explanation:

A likes Hindi. D sits second to the right of A. Only two persons sit between D and B. One who likes Tamil sits opposite to B.

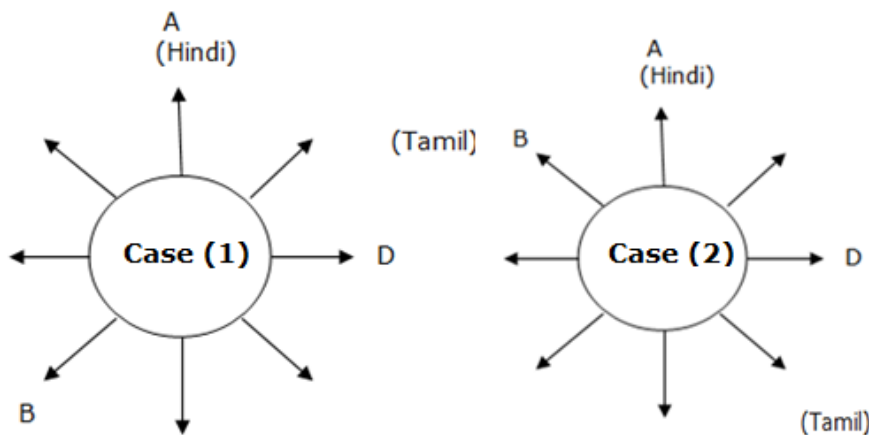

Only one person sits between B and C. C is not the immediate neighbour of A. Only one person sits between C and G. Only two persons sit between F and E. F is one of the immediate neighbours of B. E does not like Tamil. E likes history.

Expected Seating Arrangement Questions for Bank Clerk Prelims Exams

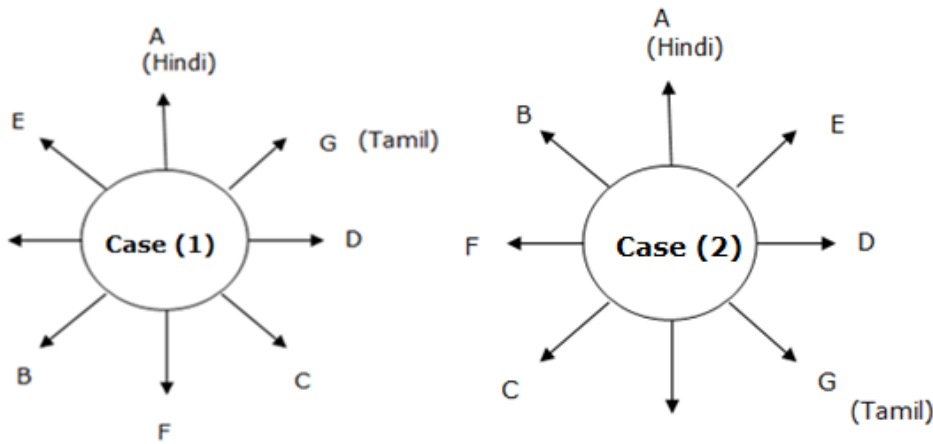

Only two persons sit between F and the one who likes History. The person one who like Maths sits second to the right one who likes Chemistry. Only one person sits between F and H. Only three persons sit between the one who likes English and Civics. D does not like Civics. One who likes chemistry is not an immediate neighbour of H.

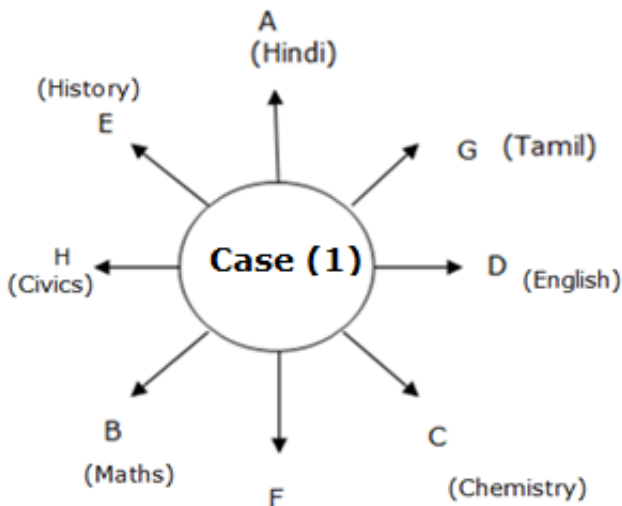

One who likes chemistry is not an immediate neighbour of H. Case (2) is not possible.

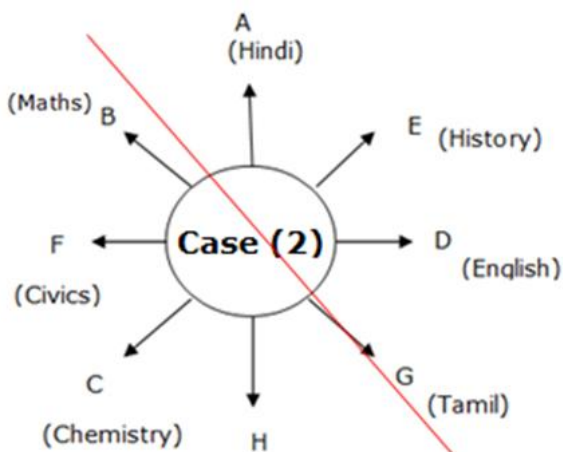

Expected Seating Arrangement Questions for Bank Clerk Prelims Exams

So the final arrangement is,

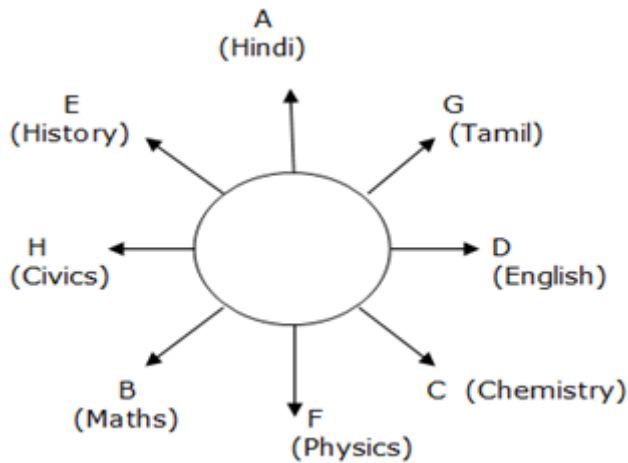

Directions (11-15):

11. Answer: A
12. Answer: E
13. Answer: D
14. Answer: C
15. Answer: A

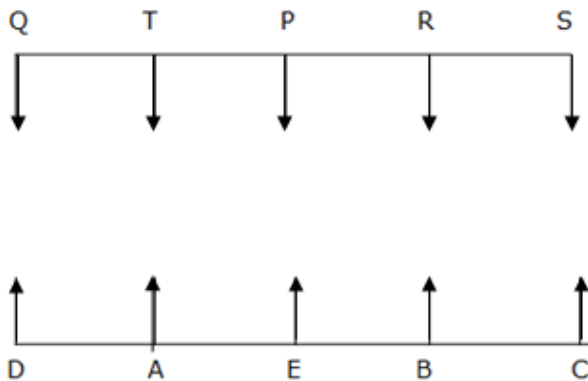

Explanation:

C sits third to the right of A. One who is sitting opposite to C sits immediate left of R.

Expected Seating Arrangement Questions for Bank Clerk Prelims Exams

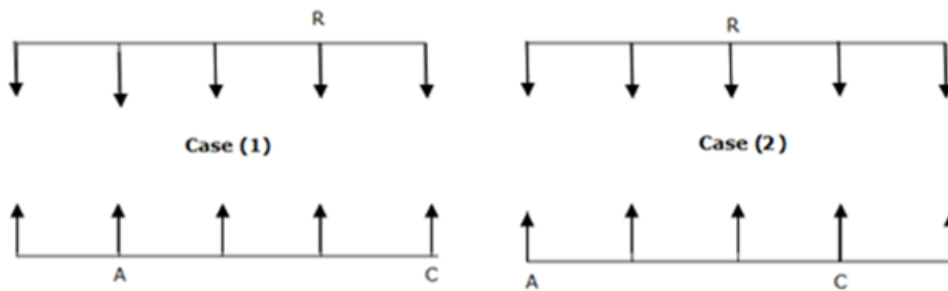

Only one person sitting between R and T. T is sitting one of the right positions of R. Only two people are sitting between T and S.

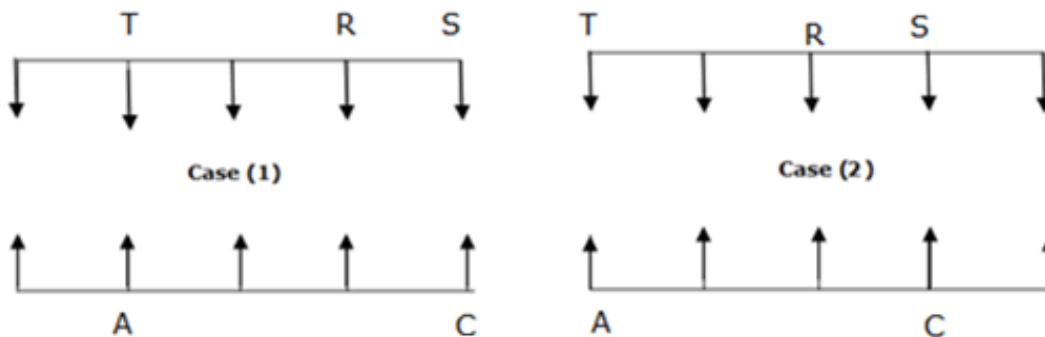

One who is sitting opposite to Q sits third to the left of B. But B is not sitting at the extreme ends. Since Case (2) is not possible.

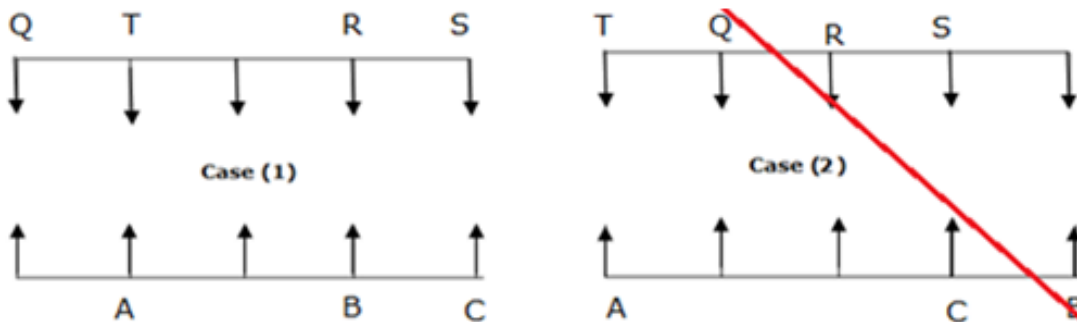

Number of persons sitting to the left of P and number of persons sitting to the Left of E is same. So the final arrangement is,

Expected Seating Arrangement Questions for Bank Clerk Prelims Exams

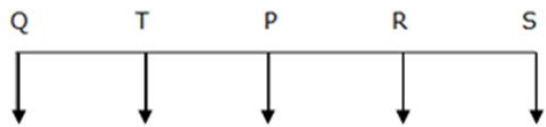

Case (1)



Directions (16-20):

- 16. Answer: D
- 17. Answer: A
- 18. Answer: D
- 19. Answer: A
- 20. Answer: C

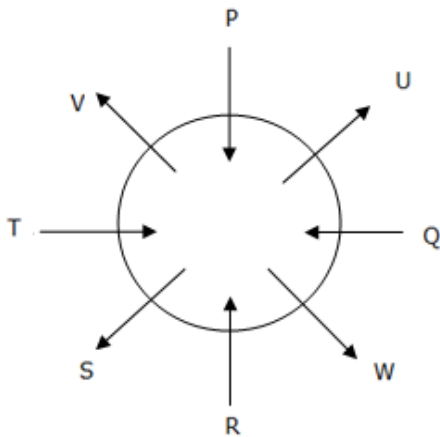

Explanation:

Q sits second to the left of P. Only two persons sits between Q and S. S is not the immediate neighbor of P.

Expected Seating Arrangement Questions for Bank Clerk Prelims Exams

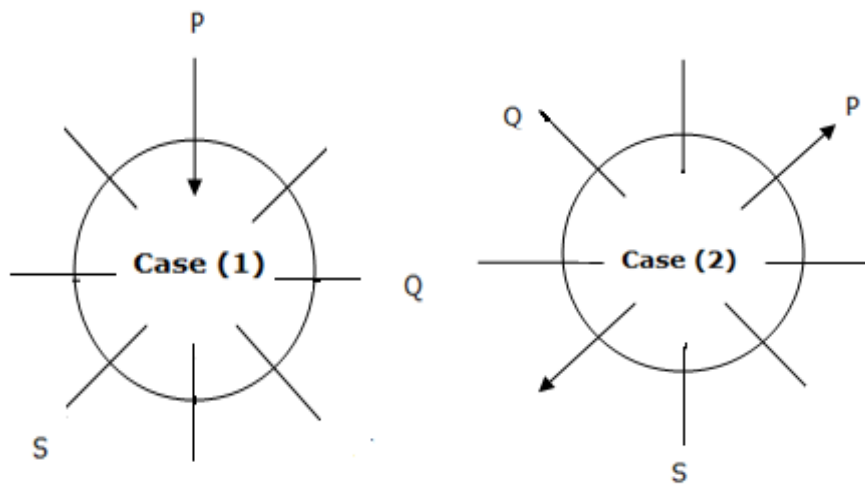

S is facing opposite direction as P. R is sitting immediate left of S. Q sits second to the right of R. Only three persons are sitting between V and W. But W is not the immediate neighbour of P.

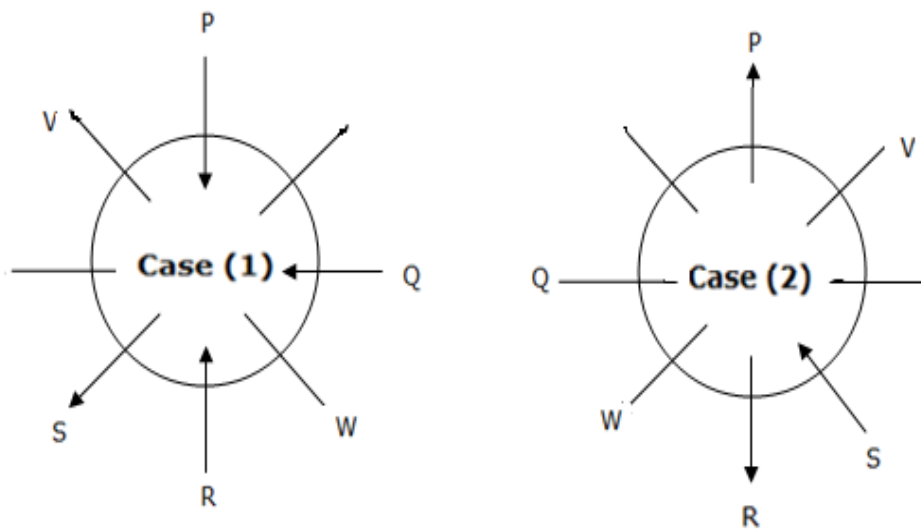

T is facing inside. U is not the immediate neighbor of S. Not more than one person sitting together are facing same direction.

Expected Seating Arrangement Questions for Bank Clerk Prelims Exams

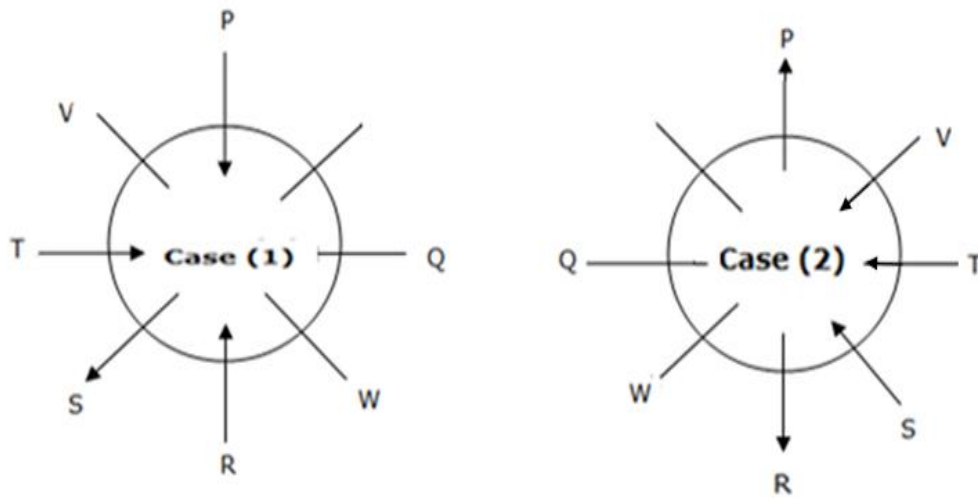

Immediate neighbours of T are facing same direction. Not more than one person sitting together is facing same direction. Since Case (2) is not possible.

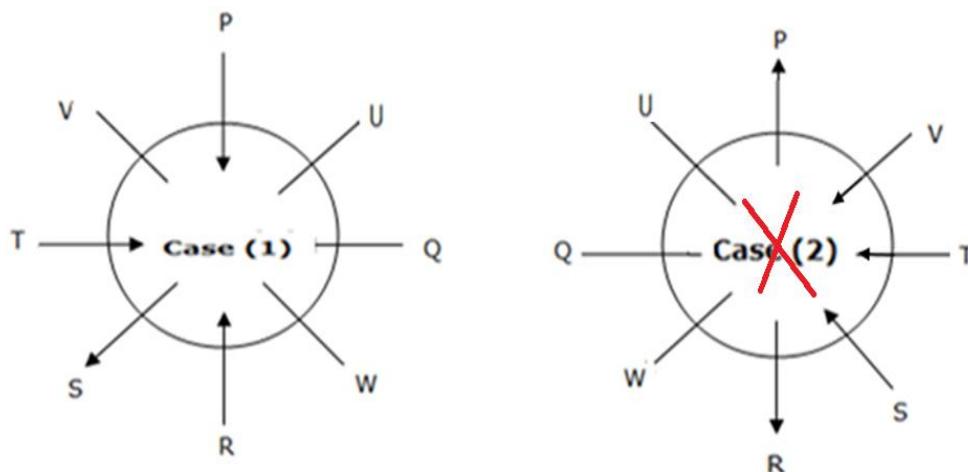

Expected Seating Arrangement Questions for Bank Clerk Prelims Exams

Immediate neighbors of T are facing same direction. U sits second to the left of W.

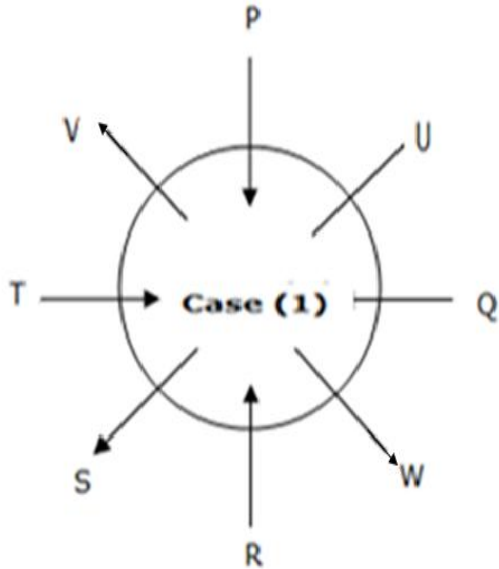

U faces opposite direction that of Q. Q faces same direction as T.

So, the final arrangement will be,

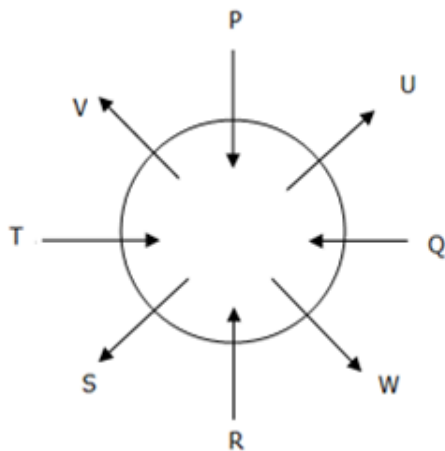

Direction (21-25):

- 21. Answer: C
- 22. Answer: A
- 23. Answer: D
- 24. Answer: B
- 25. Answer: A

Expected Seating Arrangement Questions for Bank Clerk Prelims Exams

D sits third to the right of B and three persons sit between D and I. Three persons sit between I and J. So, that case 2 is not valid-

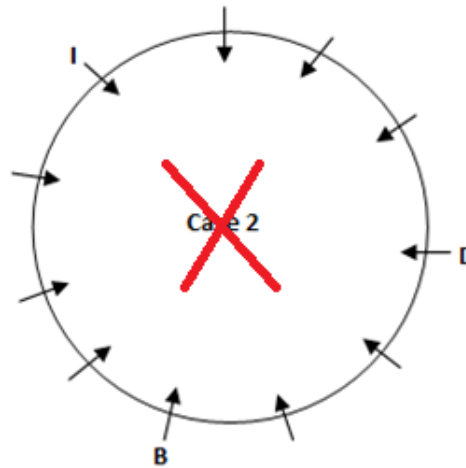
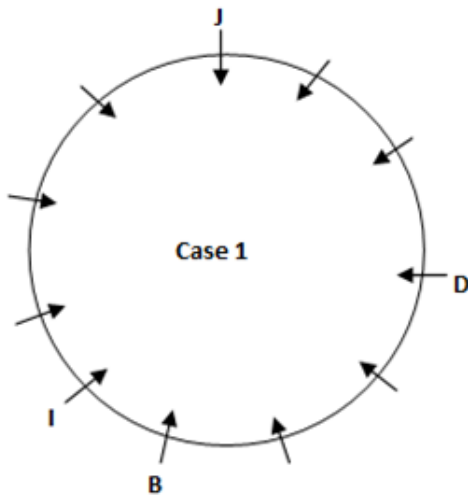

A does not sit near to I. K sits second to the right of A and K does not sit near to D. C sits third to the right of K. So that case 1(a) is not valid-

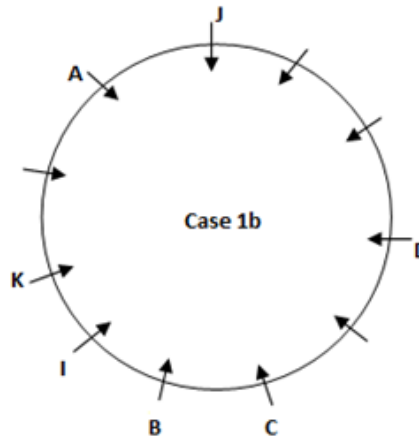
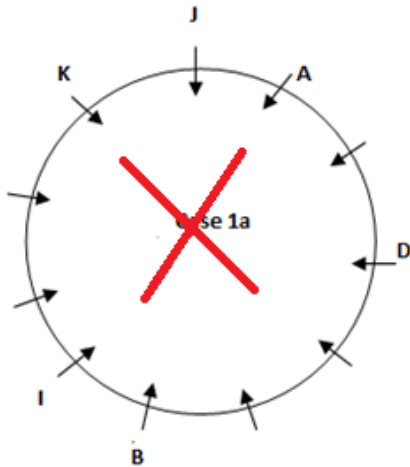

E is not the immediate neighbour of A and D. G sits second to the left of H.

Expected Seating Arrangement Questions for Bank Clerk Prelims Exams

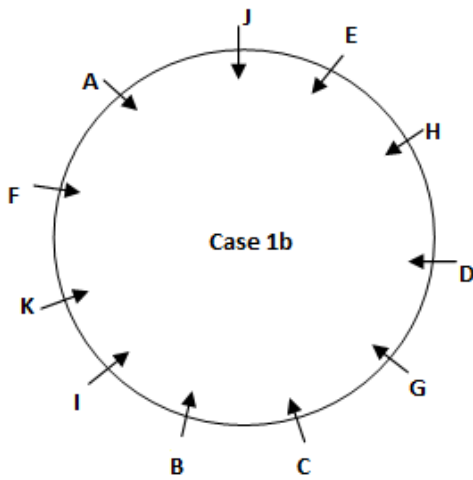

Directions (26-30):

- 26. Answer: A
- 27. Answer: C
- 28. Answer: C
- 29. Answer: A
- 30. Answer: C

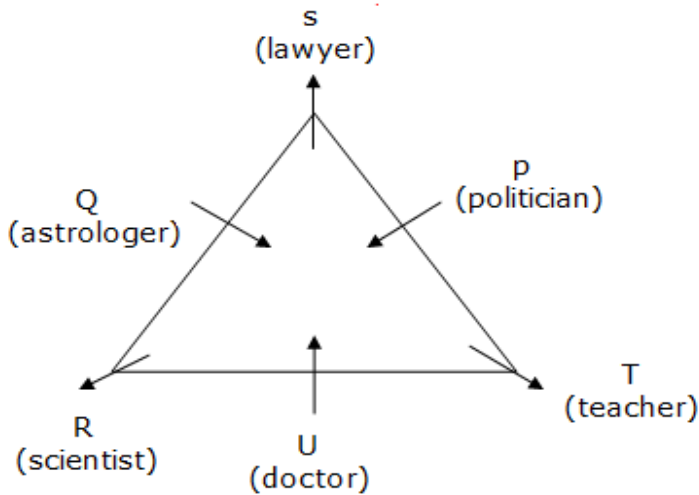

Explanation:

Astrologer sits second to the right of the politician. Two persons sits between scientist and politician. U sits second to the right of the astrologer. Lawyer sits at one of the corners of the triangle. Teacher sits immediate left of politician. Q sits second to the right of politician.

Expected Seating Arrangement Questions for Bank Clerk Prelims Exams

Case (1)

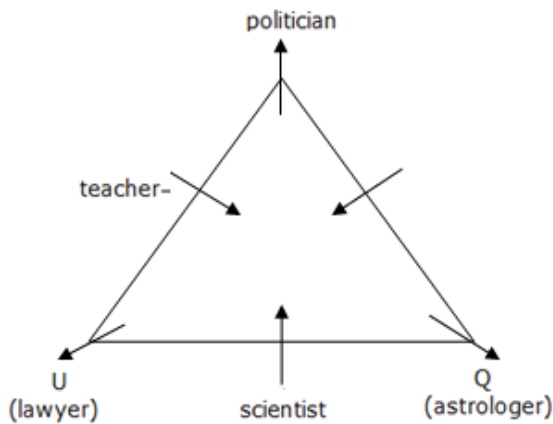

Case (2)

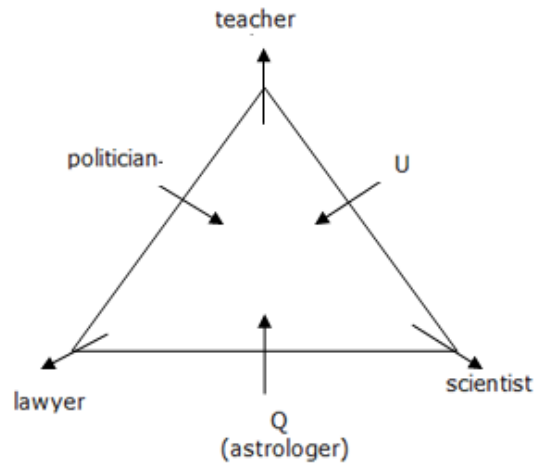

One person sits between teacher and lawyer. So case (1) is not possible.

Case (1)

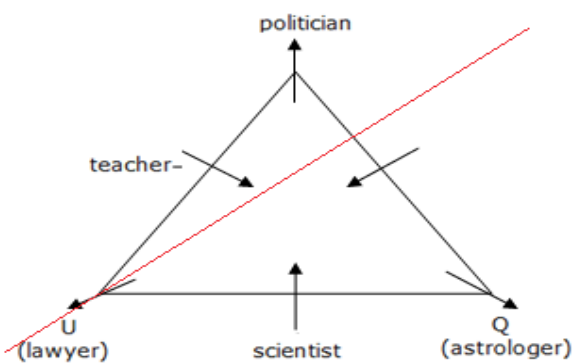

Case (2)

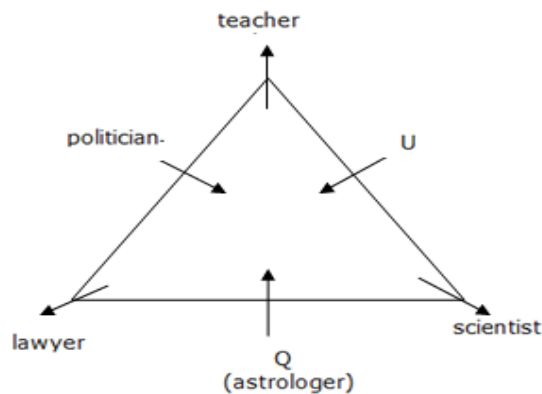

U and T sits adjacent to each other. S sits second to the left of T.

Expected Seating Arrangement Questions for Bank Clerk Prelims Exams

Case (2a)

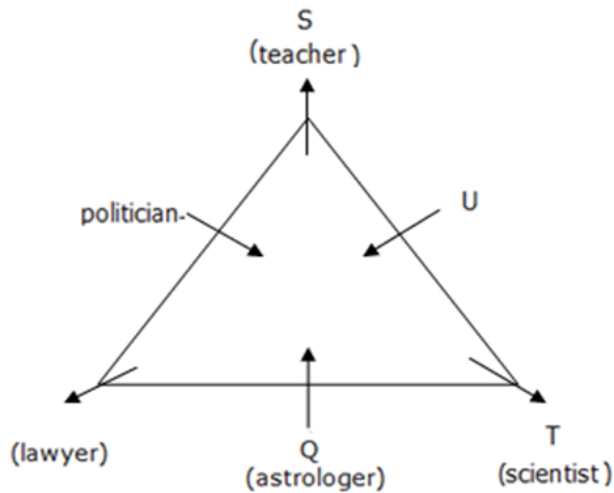

Case (2b)

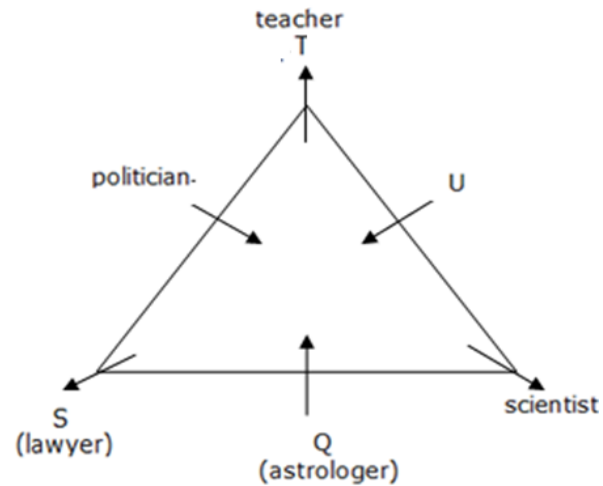

P sits immediate left of T. S is not a doctor. So case (2a) is not possible.

Case (2a)

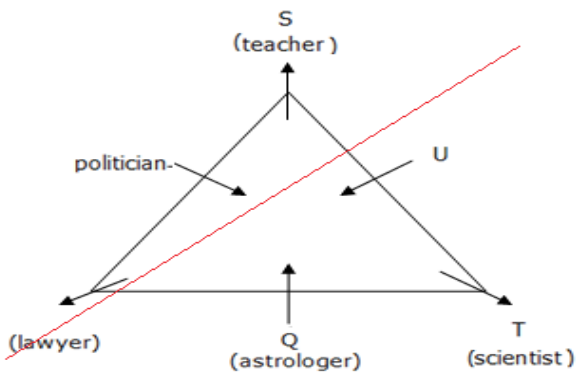

Case (2b)

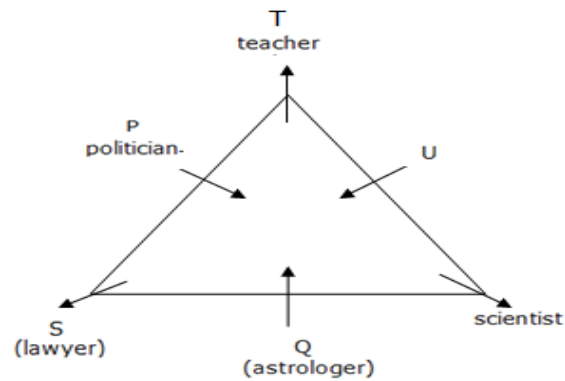

So the final arrangement is,

Expected Seating Arrangement Questions for Bank Clerk Prelims Exams

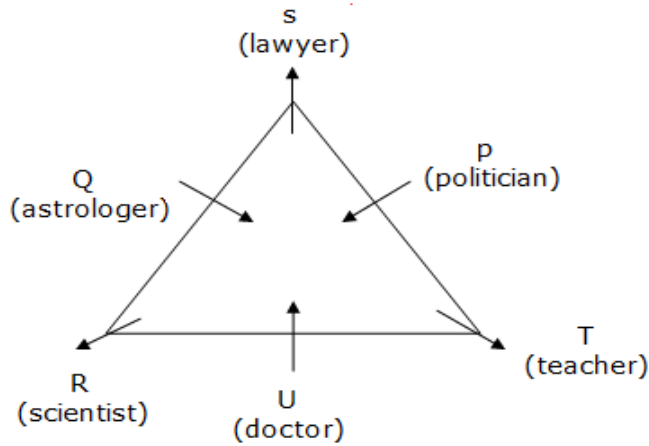

Directions (31-35):

- 31. Answer: C
- 32. Answer: D
- 33. Answer: A
- 34. Answer: B
- 35. Answer: C

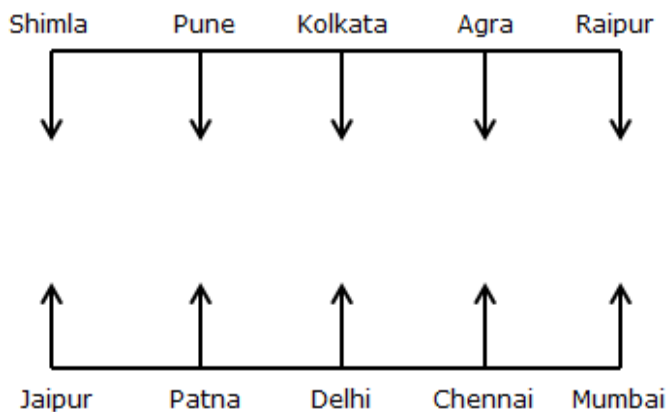

Explanation:

The person who goes to Mumbai and the person who goes to Shimla are sits diagonally opposite to each other. The person goes to Agra sits opposite to one who is adjacent to the person who goes to Mumbai. One person sits between Agra and Pune.

Expected Seating Arrangement Questions for Bank Clerk Prelims Exams

Case(1)

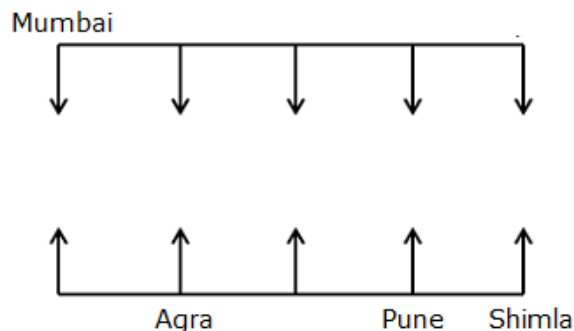

Case (2)

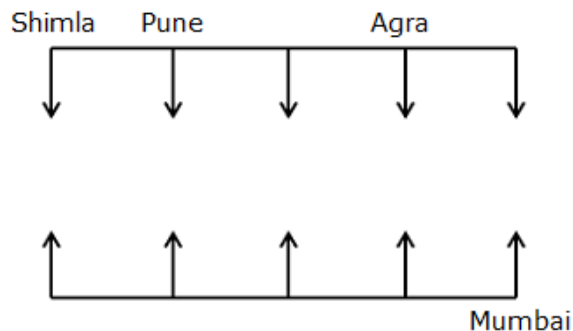

Case (3)

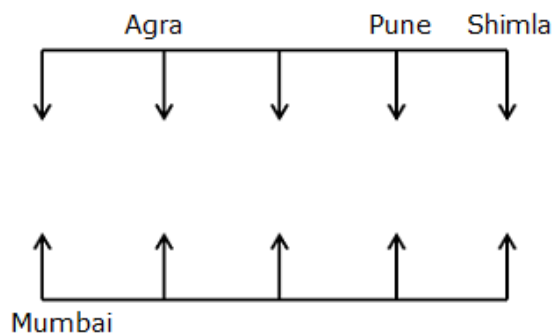

Case (4)

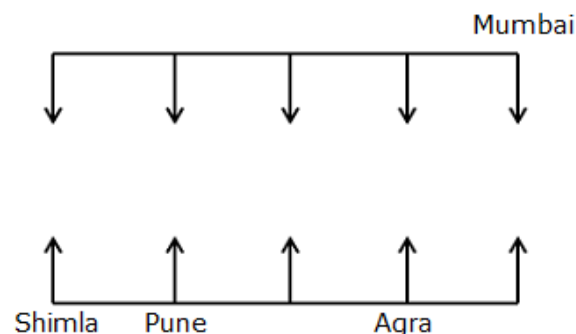

Person from Jaipur sits one of the extreme ends of the row and also sits second to either side of the person who goes to Delhi and both are in same row with the person who goes to Chennai. Person who goes to Chennai sits immediate right of the person who goes to Delhi. Person who goes to Kolkata sits second to the right of the person who goes to Raipur.

Expected Seating Arrangement Questions for Bank Clerk Prelims Exams

Case (1)

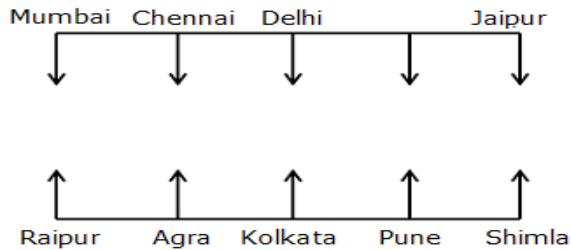

Case (2)

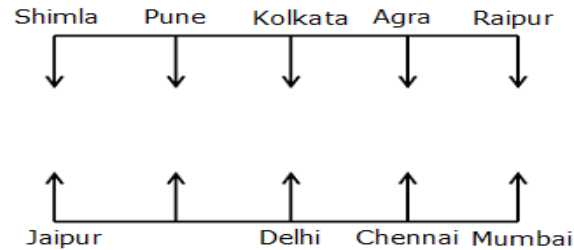

Case (3)

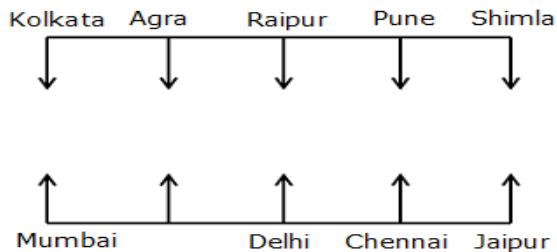

Case (4)

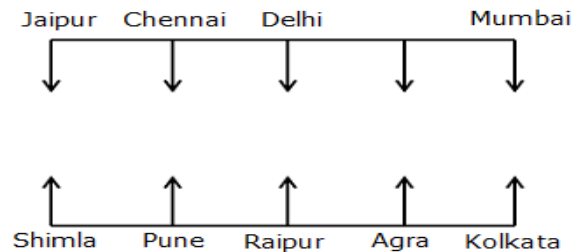

Person who goes to Agra is not facing the person who goes to Patna. Person to Patna faces north. So cases (1), (3) and (4) are not possible.

Case (1)

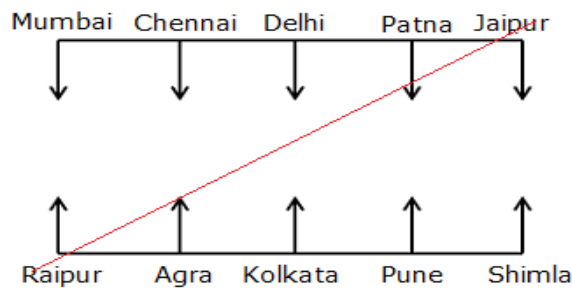

Case (2)

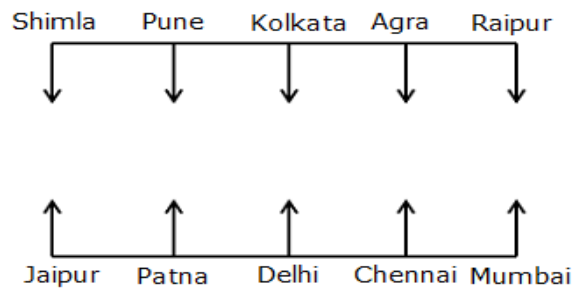

Case (3)

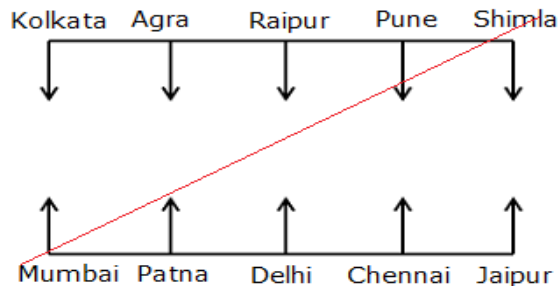

Case (4)

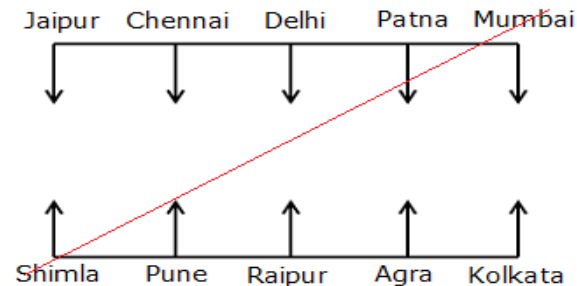

So the final arrangement is,

Expected Seating Arrangement Questions for Bank Clerk Prelims Exams

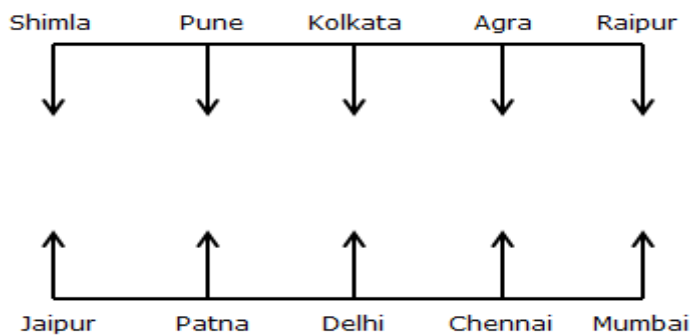

Directions (36-40):

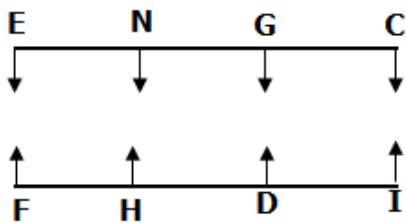

36. Answer: B

37. Answer: E

38. Answer: D

39. Answer: C

40. Answer: E

Explanation:

F faces the person who sits second to the right of G.

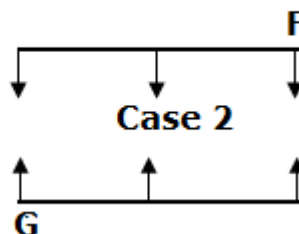
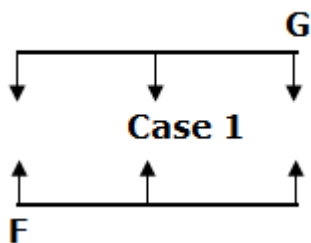

E and C sit in the same row.

D sits in Row 1.

C and F don't sit in the same row.

H is facing N.

Expected Seating Arrangement Questions for Bank Clerk Prelims Exams

In case 1 E and C sits in row 2. But in case 2, E and C sit in row 1 because of F and C doesn't sits in same row. And also D sits in row 1, but from the statement H is facing N, Either H or N is seated in Row 1. So it is not possible to seated five persons in a row. So this case is eliminated.

From the statement, H is facing N, H doesn't seated opposite to F.

H sits second to the left of I.

H doesn't sits at any extreme ends.

F and C don't face each other.

Now the final arrangement becomes

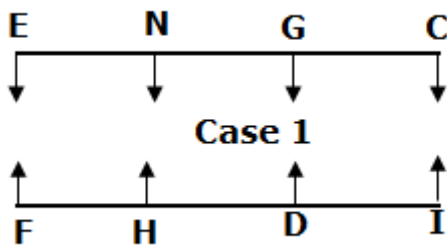

Directions (41-45):

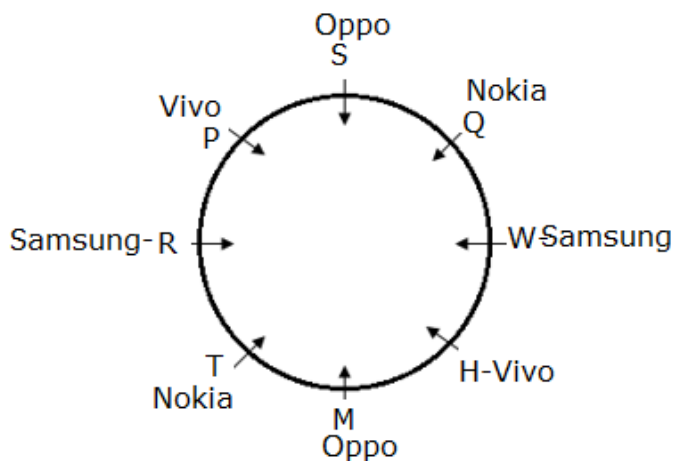

41. Answer: E

42. Answer: D

43. Answer: C

44. Answer: C

45. Answer: E

Explanation:

Expected Seating Arrangement Questions for Bank Clerk Prelims Exams

Only one person sits between M and R. Two persons sit between R and Q. Q and M are not immediate neighbours. Person sitting on opposite sides have same mobiles. R has Samsung mobile and sits second to the right of S.

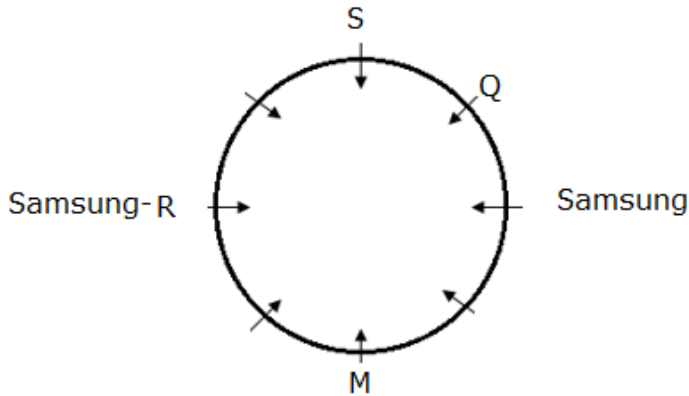

The one who has Nokia mobile does not sit immediate left of the one who has Samsung mobile. S and the one who has Oppo mobile are not immediate neighbour. W is an immediate neighbour of the one who has Vivo mobile. The one who has Nokia mobile sits second to the right of H. T does not have Vivo mobile.

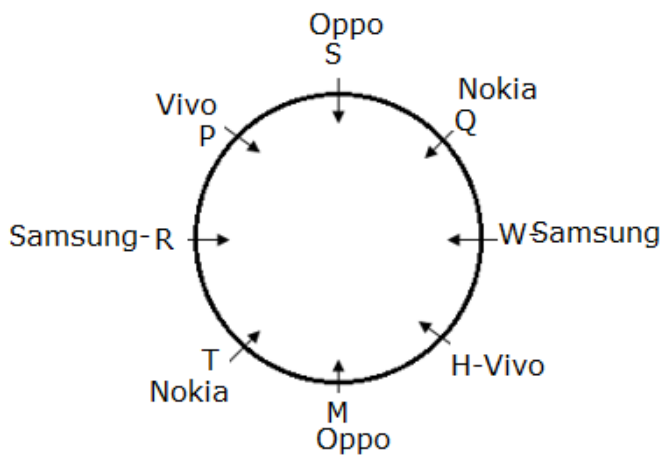

Directions (46-50):

Expected Seating Arrangement Questions for Bank Clerk Prelims Exams

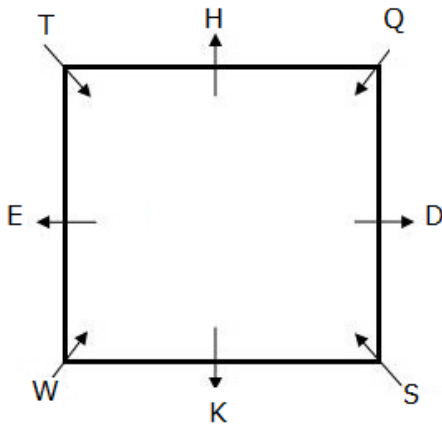

46. Answer: C

47. Answer: C

48. Answer: B

49. Answer: A

50. Answer: D

Three persons sit between K and H. As many persons sit between H and D sits between D and K. Q sits immediate left of D. Q and K are not immediate neighbours.

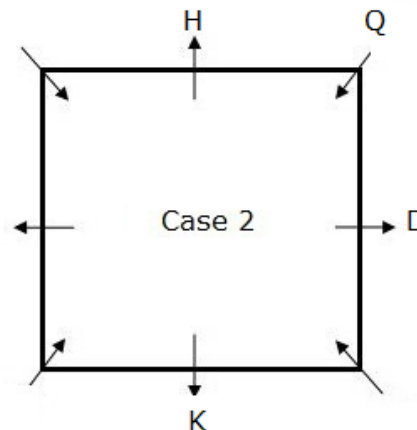
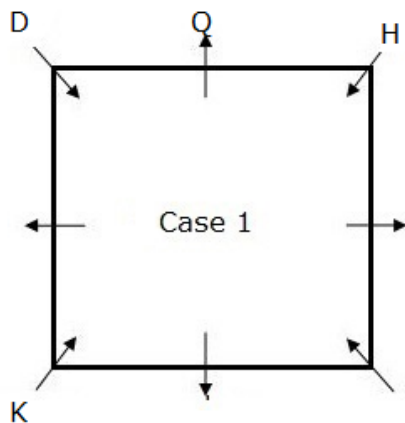

As many persons sit between T and W sits between W and S. W does not faces away from the centre. H and S are not immediate neighbours. Q does not sit opposite to S.

Expected Seating Arrangement Questions for Bank Clerk Prelims Exams

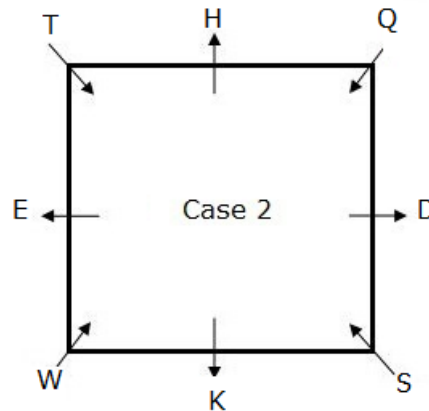
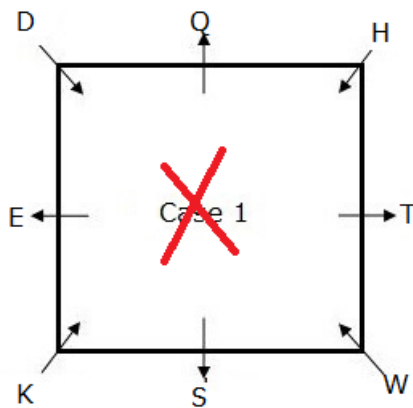

Case 1 will be dropped because Q does not sit opposite to S.

[Click Here for More Reasoning Practice Questions PDFs](#)

[Click Here to Join Our What's App Group & Get Instant Notification on Study Materials & PDFs](#)

[Click Here to Join Our Official Telegram Channel](#)